

# Competition grounds / Phase B Chablis 2017

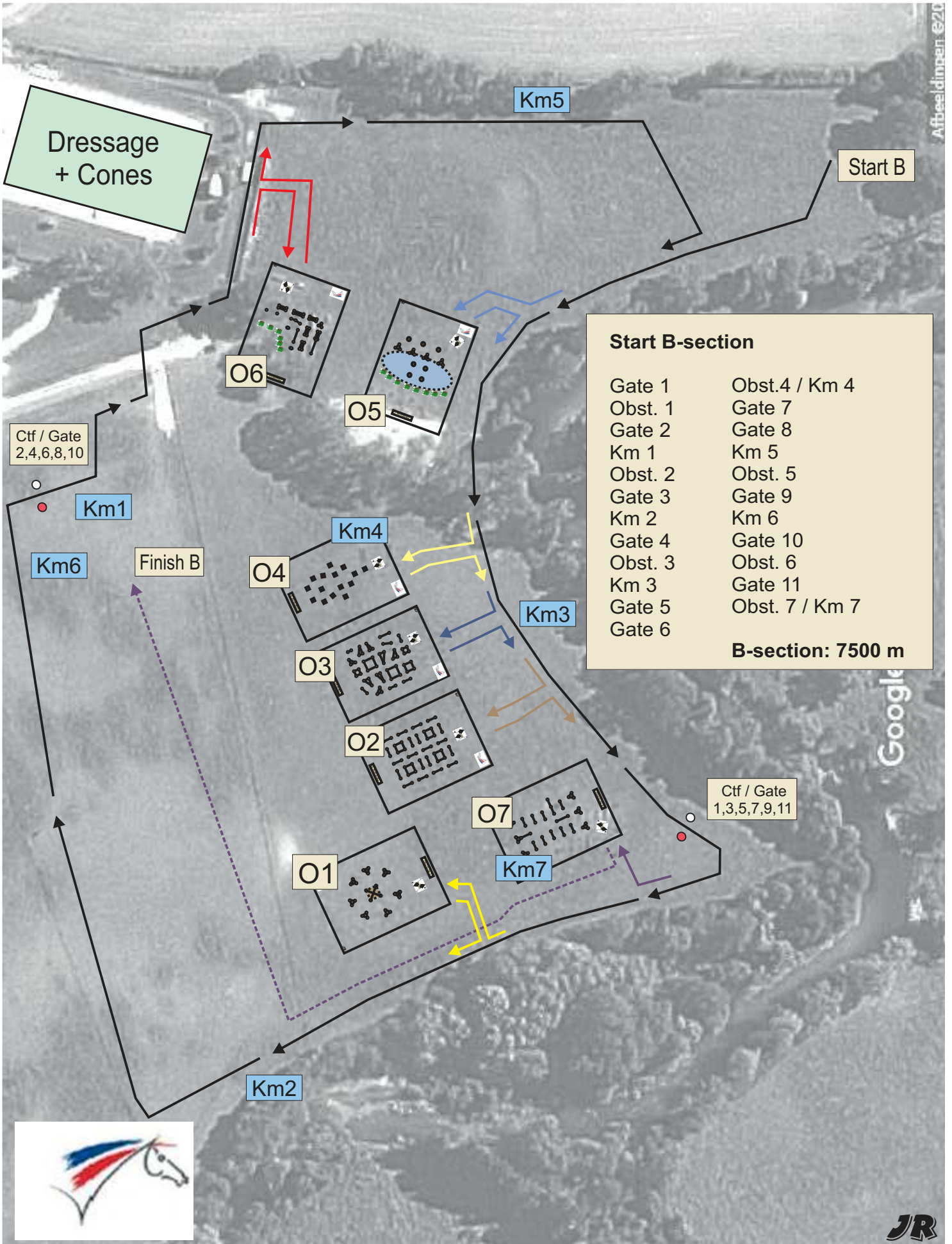

# Obstacle 1

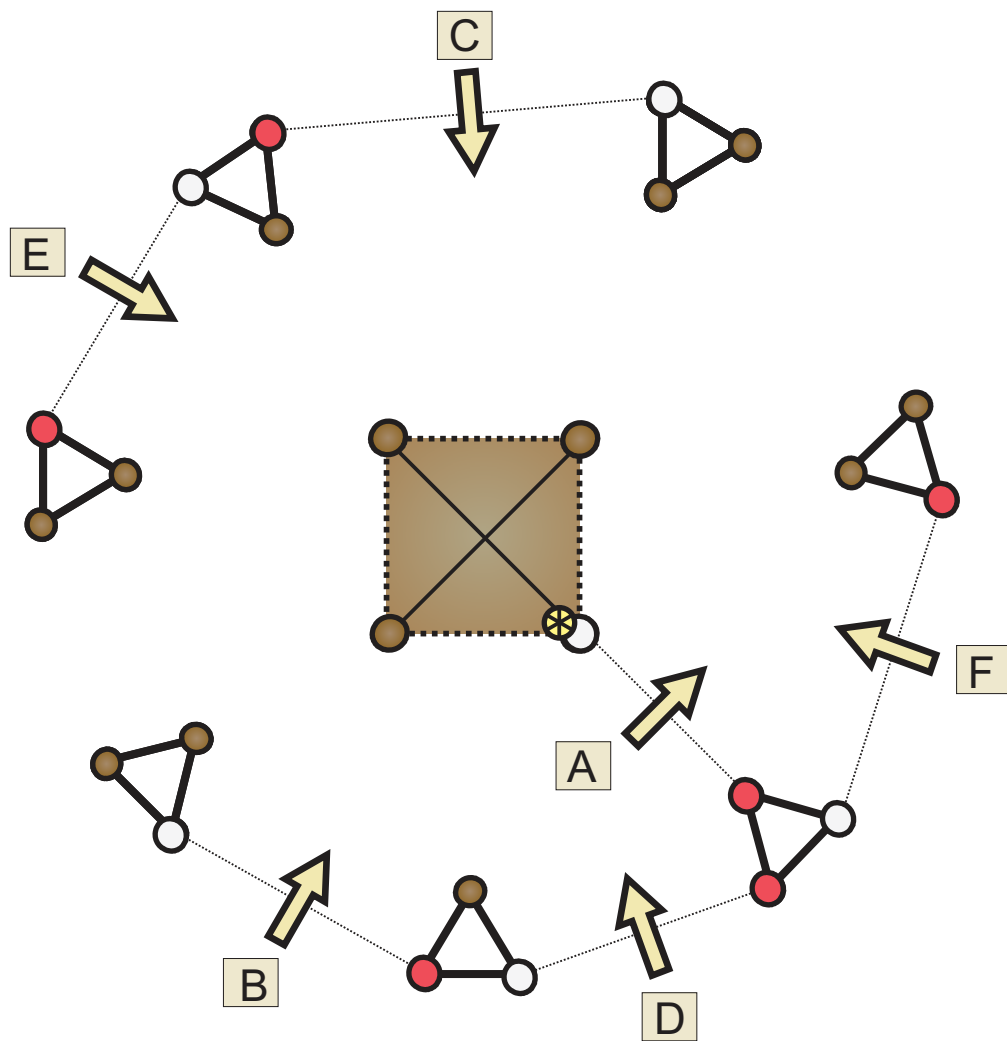
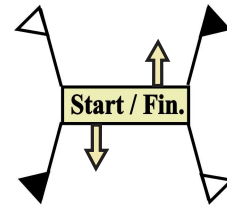

⊗ = Tombants / Knock down (1x)



# Obstacle 2

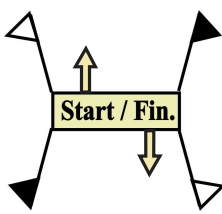
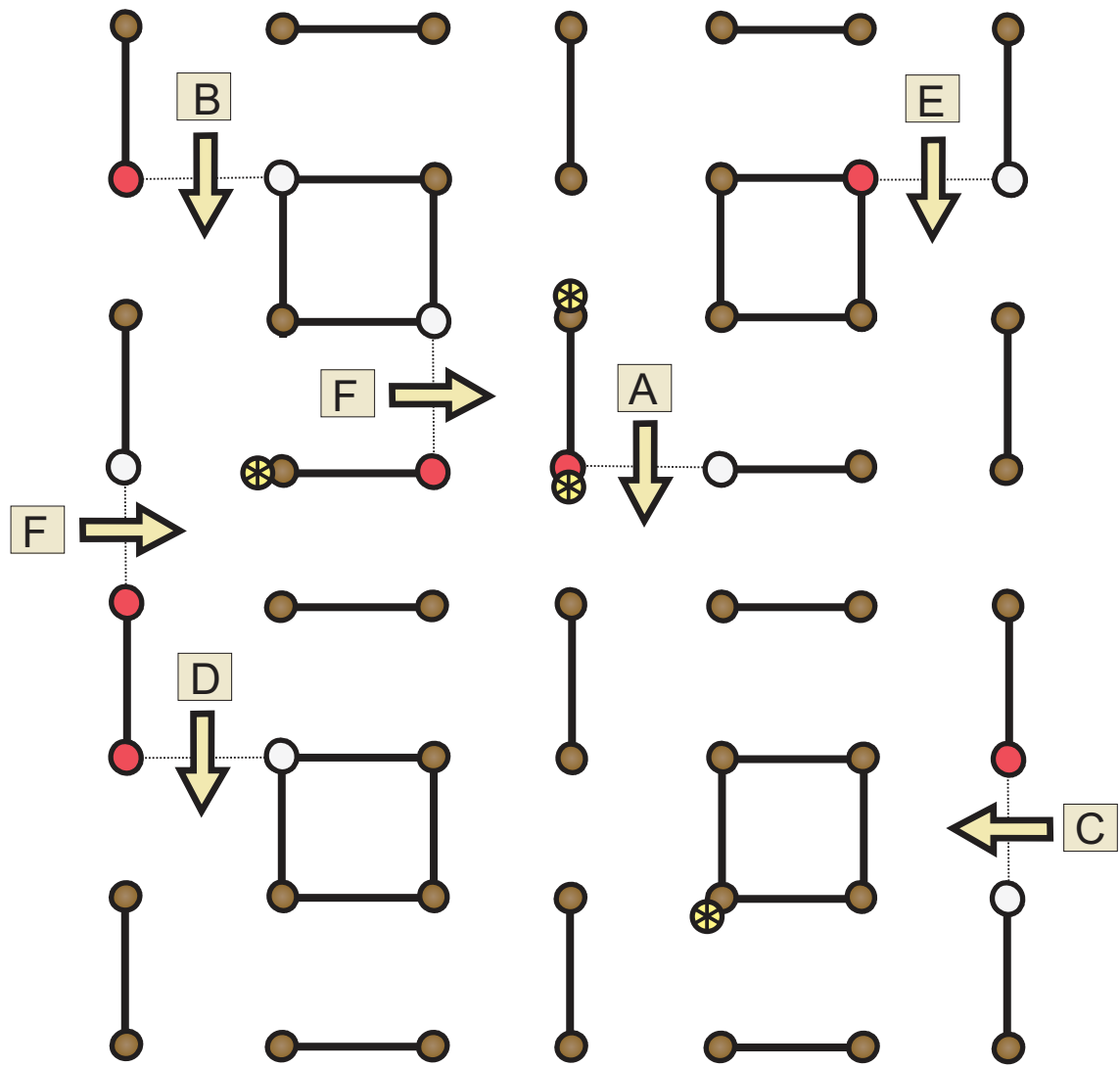

⊗ = Tombants / Knock down (4x)

# Obstacle 3

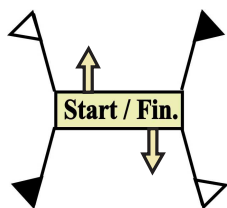
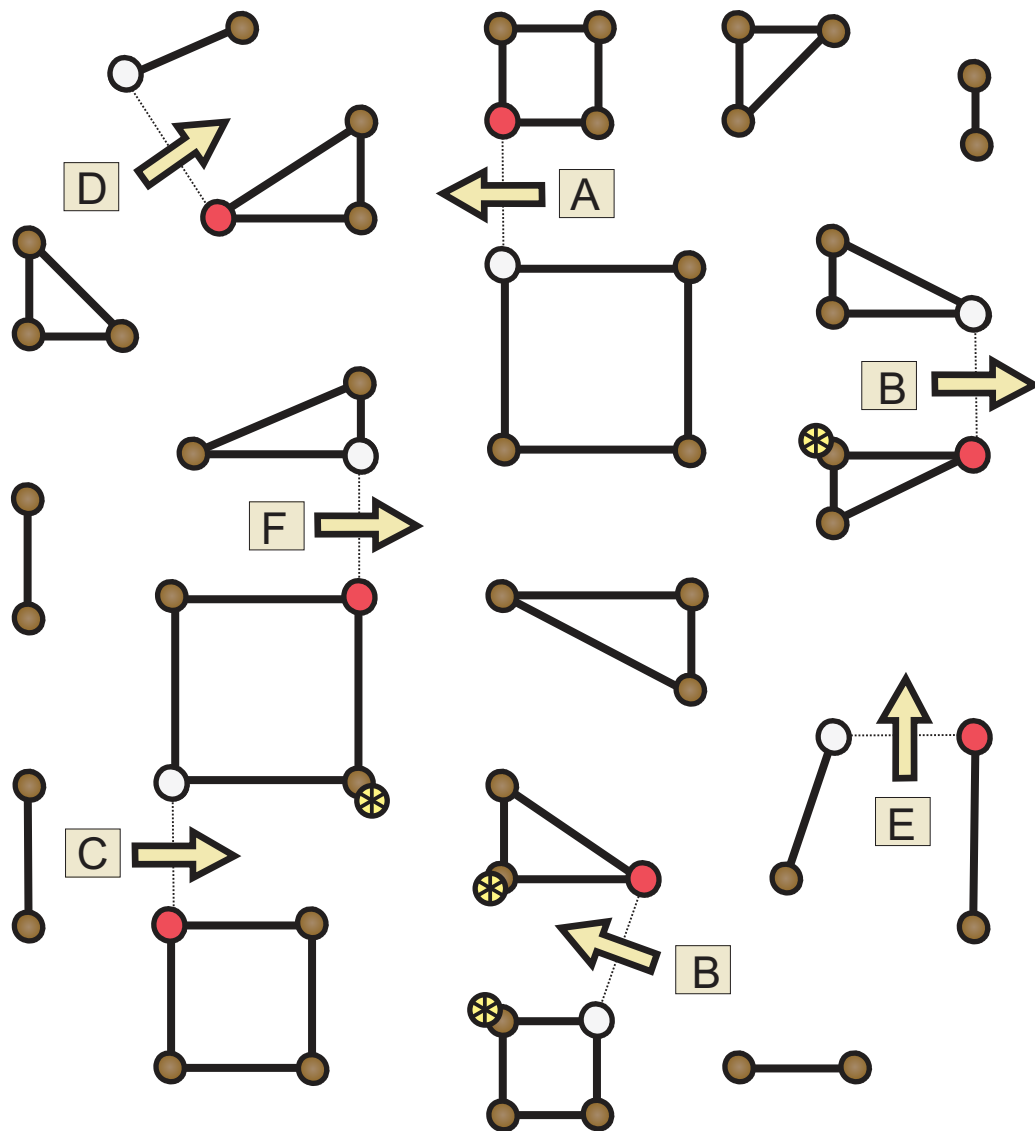

= Tombants / Knock down (4x)

# Obstacle 4

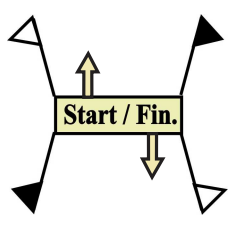
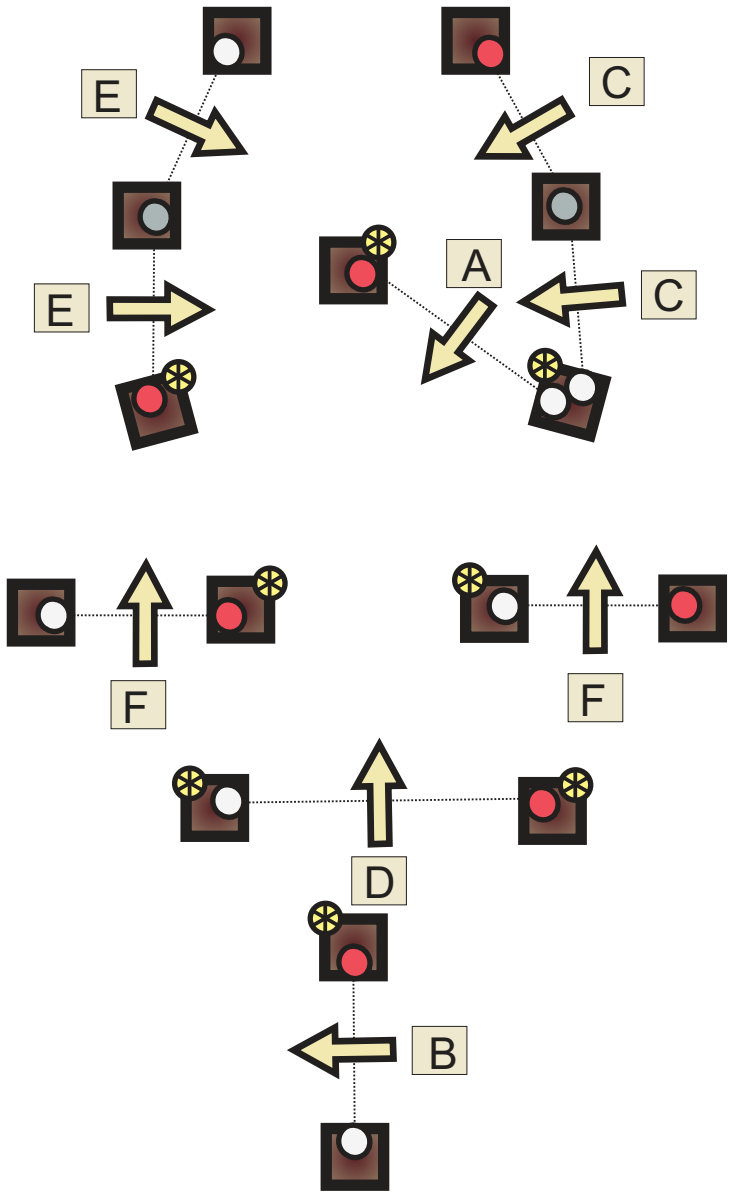

 = Tombants / Knock down (8x)

# Obstacle 5

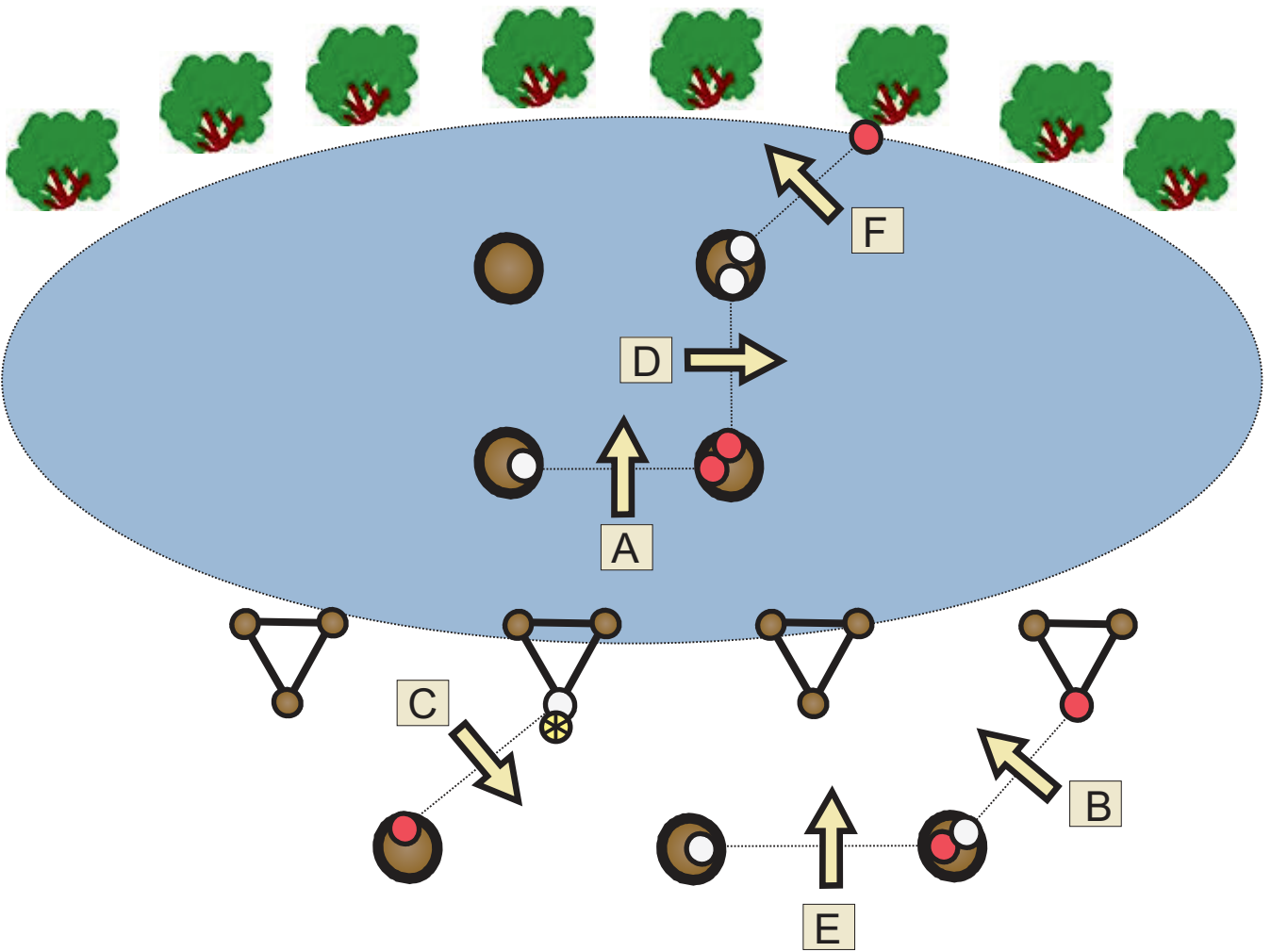

⊗ = Tombants / Knock down (1x)

# Obstacle 6

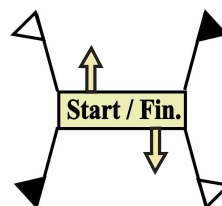
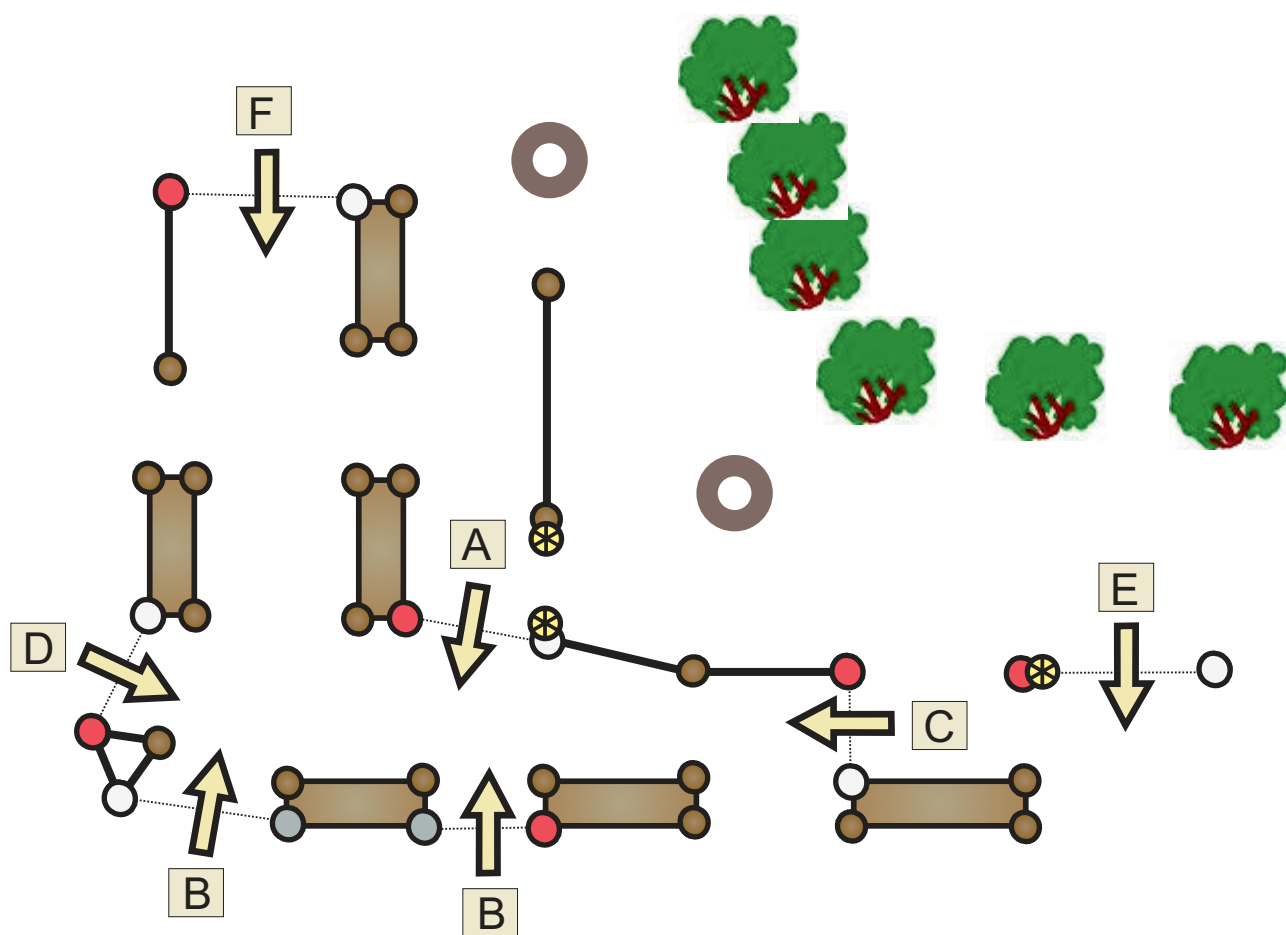

⊗ = Tombants / Knock down (3x)

# Obstacle 7

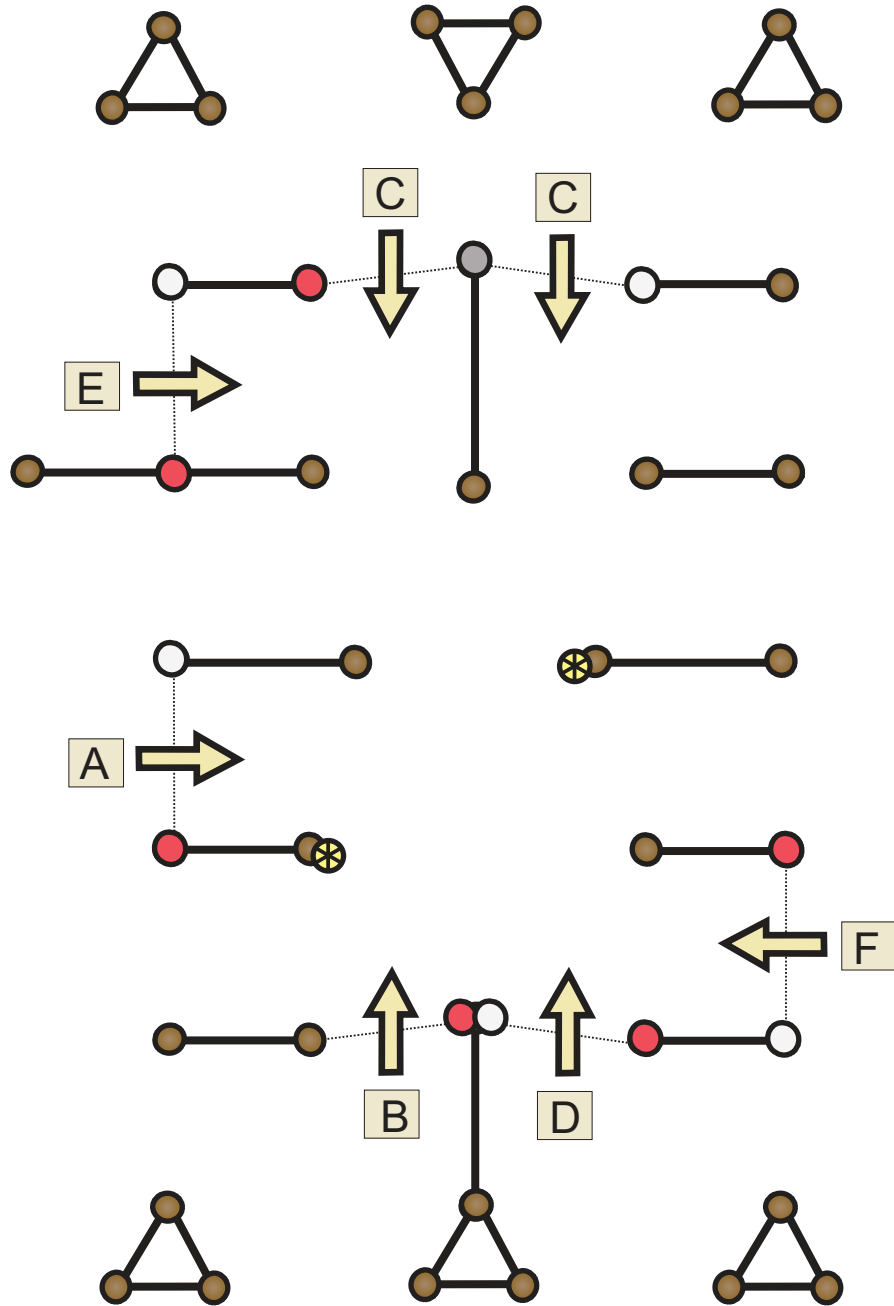
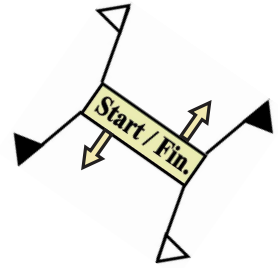

⊗ = Tombants / Knock down (2x)